

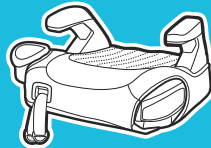

# TURBOBOOSTER LX

featuring TrueShield™ Technology

**Read This Instruction Manual**

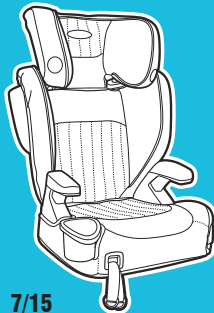

**Do not install or use  
this child restraint until you read  
and understand the instructions in  
this manual.**

**FAILURE TO PROPERLY USE THIS  
CHILD RESTRAINT INCREASES  
THE RISK OF SERIOUS INJURY  
OR DEATH IN A SUDDEN STOP OR  
CRASH.**

# 1 Important

*Pages 5-19*

**1-A Quick Guide to Your Manual**

**1-B Welcome to the Graco Family**

**1-C Before You Begin**

Register This Car Seat

If You Need Help

Certification

Car Seat's Useful Life

Vehicle Seat Protection

Warm Weather Use

**1-D Safety Warnings**

# 2 Features

*Pages 20-23*

**2-A Car Seat Features**

## **3 Booster**

*Pages 24-30*

**3-A Booster Use**

**3-B Install Booster**

**3-C Install Backless Booster**

## **4 Securing Child**

*Pages 31-40*

**4-A Securing Child Backed Booster**

**4-B Securing Child Backless Booster**

## **5 Accessories**

*Page 41*

## **6 Vehicle Information**

*Pages 42-46*

- 6-A How to Remove Lower Anchor Connectors**
- 6-B Choosing Vehicle Seat Location**
- 6-C Unsafe Vehicle Seat Location**
- 6-D Vehicle Seat Belts**

## **7 Care & Cleaning**

*Pages 47-50*

- 7-A Cleaning Seat Pad**
- 7-B Cleaning Lower Anchor Straps**

# 1-A Quick Guide to Your Manual

This car seat is for children: **Booster: 30-110 lb (14-50 kg) 38-57 in**

## *Car Seat Assembly (On Select Models)*

### **Adult Assembly Required**

#### **1. Pull and Hold Height Adjust Lever**

Located on the back of the head support.

#### **2. Attach Head Support**

slide the head support into the seat back until they snap into place.

**CHECK** to make sure the two pieces are securely snapped together by pulling on them.

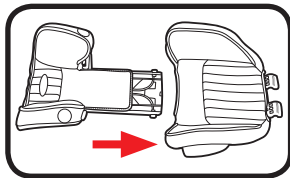
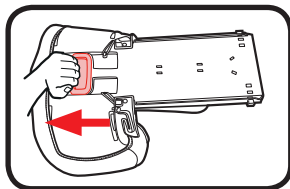

**1 Important**

**1 Important**

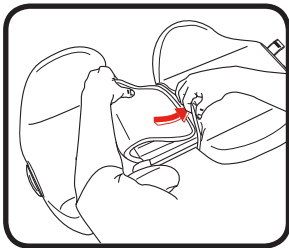

### **3. Head Support Fabric**

Insert the fabric from the head support underneath the fabric on the lower back support as shown.

To make insertion of fabric easier, slide the upper and lower back pieces apart by pulling the adjustment lever.

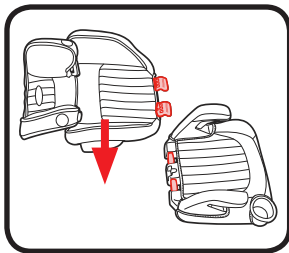

### **4. Attach Seat Back to Base**

The “U”-shaped hooks on bottom of the seat back will interlock with bars on the base.

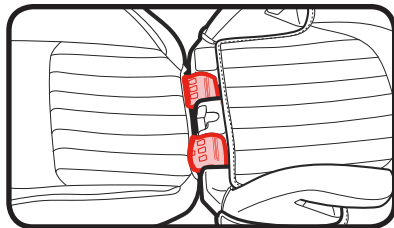

## 5. **Raise Seat Back**

Once the seat back is securely attached to the base, push backrest up

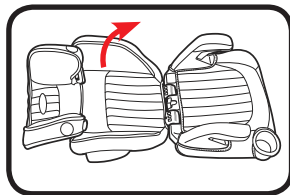

## **Assembly Complete**

Your Graco booster seat is now ready to use.

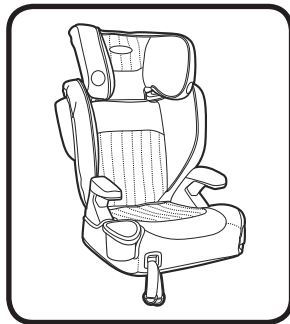

**i** 1 Important

## ***Get to Know Your Car Seat***

Review section 2-A to see all of the features of this booster seat.

## ***What Seating Location Should I Use?***

***The best seating location for this booster seat is one that:***

- Is recommended by your vehicle owner's manual, and
- Results in a secure installation of this booster seat.

Some vehicles have specific requirements for where the booster seat can be installed, so be sure to check your vehicle owner's manual for available seating positions, if any. For example, sometimes the center rear seat has a lap belt only vehicle seat belt, which cannot be used with this booster seat.

Review section 6-B, 6-C, 6-D of this manual AND your vehicle owner's manual.

**According to accident statistics, the safest place for your child in any vehicle is the back seat. The center of the back seat can be the safest during a possible side impact.**





## Using The Car Seat Correctly

To make sure your child is secured properly, review section 3 and 4 to fit your child.

### When Installing As a Booster

#### Lower Anchor System

The lower anchor system consists of lower anchor bars, which are built-in to your vehicle, and connecting hooks that are built-in to your car seat.

Review section 3 of this manual AND your vehicle owner's manual.

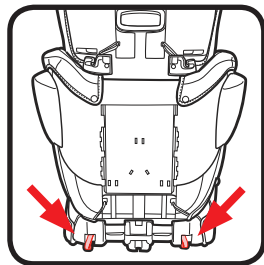

#### Vehicle Seat Belt

There is one type of vehicle seat belt that can be used: Lap/Shoulder Seat Belt.

Review section 3 of this manual AND your vehicle owner's manual.

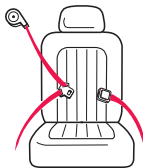

1 Important

## **Booster Installation**

### **Use Lap/Shoulder Belt Only**

Review section 3

### **Position Lap Belt**

Lap belt must go in front of armrest and lie low across your child's hips and thighs.

Review section 3

### **Position Shoulder Belt**

Shoulder best lies across shoulder between neck and edge of shoulder.

Review section 3

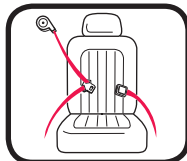

**Highback**



**Backless**

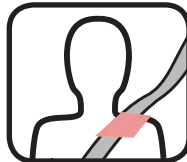

## **1-B Welcome to the Graco Family!**

Your child's safety depends on you. No car seat can guarantee protection from injury in every situation, but proper use helps reduce the risk of serious injury or death. Even if this car seat seems easy to figure out on your own, you must follow the detailed instructions in this instruction manual to ensure the steps below are performed correctly.



**1 Important**



**1 Important**

## **1-C Before You Begin**

### ***Register This Child Restraint***

Please fill out the prepaid registration postcard attached to the harness and mail it in today **or register online at [www.gracobaby.com/carseatregistration](http://www.gracobaby.com/carseatregistration).**

Child restraints could be recalled for safety reasons. You must register this restraint to be reached in a recall. Send your name, address, and the restraint's model number and manufacturing date to:

Graco Children's Products, Inc.

Attn: Customer Service

3 Glenlake Parkway Atlanta, GA 30328

**or register online at [www.gracobaby.com/carseatregistration](http://www.gracobaby.com/carseatregistration)**

or call 1-800-345-4109

For recall information, call the U.S. Government's Vehicle Safety Hotline at

1-888-327-4236

(TTY: 1-800-424-9153), or go to <http://www.NHTSA.gov>.

For future reference or if you change addresses, record the model name, model number, date of manufacture and purchase date of this car seat on the below. You can find this information either on the registration card if you still have it or on the date label located on the back of the car seat.

**Model Name** \_\_\_\_\_

**Model Number** \_\_\_\_\_

**Date of Manufacture** \_\_\_\_\_

**Date of Purchase** \_\_\_\_\_



**1 Important**

### ***If You Need Help***

In the U.S.A, please contact our Customer Service Department with any questions you may have concerning parts, use, or maintenance. When you contact us, please have your product's model number and date of manufacture ready so that we may help you efficiently. These numbers can be found on a sticker on the back side of your car seat.

For additional resources or to get your car seat checked by a child passenger safety technician, please visit the following web sites:

[www.nhtsa.gov](http://www.nhtsa.gov) • [www.seatcheck.org](http://www.seatcheck.org) • [www.safekids.org](http://www.safekids.org)



1 Important

### ***Certification***

This child restraint meets or exceeds all applicable requirements of Federal Motor Vehicle Safety Standard 213 for use in motor vehicles.



This child restraint is NOT certified for use in aircraft when used as a booster seat because aircrafts do not have shoulder belts.

### ***Car Seat's Useful Life***

STOP using this car seat and throw it away 10 years after the date of manufacture. Look for date of manufacture label on back of the car seat.

Graco Children's Products Inc. advises against loaning or passing along a car seat unless you know the complete history of the product. We also advise against purchasing a car seat second hand.

### ***Vehicle Seat Protection***

Protect vehicle seat. Use a car seat mat, towel, or thin blanket under and behind car seat.



1 Important

### ***Warm Weather Use***

Car seat parts can get very hot in the sun or warm weather. **To avoid burns, always check before putting child in car seat.**

## **1-D Safety Warnings**

**No car seat can guarantee protection from injury in every situation, but proper use helps reduce the risk of serious injury or death. **READ THIS MANUAL CAREFULLY.****

### **! WARNING!**

**Failure to follow these instructions and child restraint's labels can result in child striking the vehicle's interior during a sudden stop or crash.**

**1 Important**

- ! Review your vehicle owner's manual for more information about air bags and car seat use.**
- ! If your vehicle does not have a back seat, review your vehicle owner's manual.**
- ! Select a suitable location for the car seat in your vehicle.**
- ! Always secure car seat with the lower anchor hooks or a vehicle seat belt, when unoccupied. In a crash, an unsecured car seat can injure passengers.**
- ! If car seat is in a crash, it must be replaced. DO NOT use it again! A crash can cause unseen damage and using it again could result in serious injury or death.**



- ! DO NOT use car seat if it is damaged or missing parts.**
- ! DO NOT use accessories or parts other than those provided by Graco. Their use could alter the performance of the car seat.**
- ! Never leave child unattended, even when sleeping. Child may become tangled in harness straps and suffocate or strangle.**



- ! Never attach two lower anchor connectors to one vehicle lower anchor bar unless specifically allowed by the vehicle manufacturer.**

## 2-A Car Seat Features



2 Features

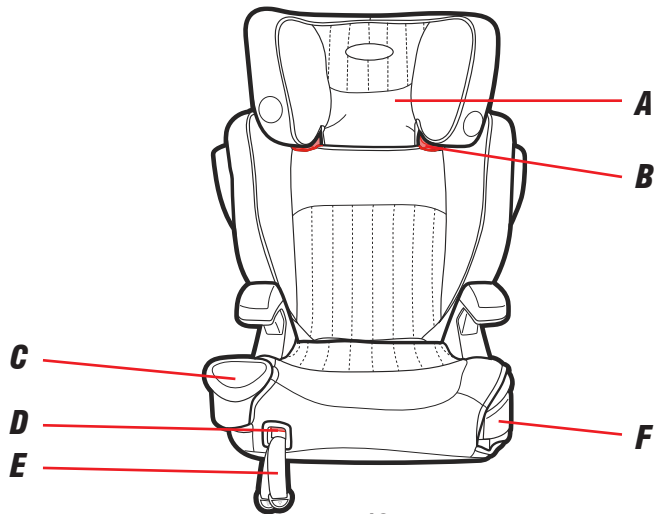

- A Head Support***
- B Shoulder Belt Guide***
- C Cup Holder***
- D Lower Anchor Adjuster Button***
- E Lower Anchor Adjustment Straps***
- F Storage Compartment***



## 2 Features

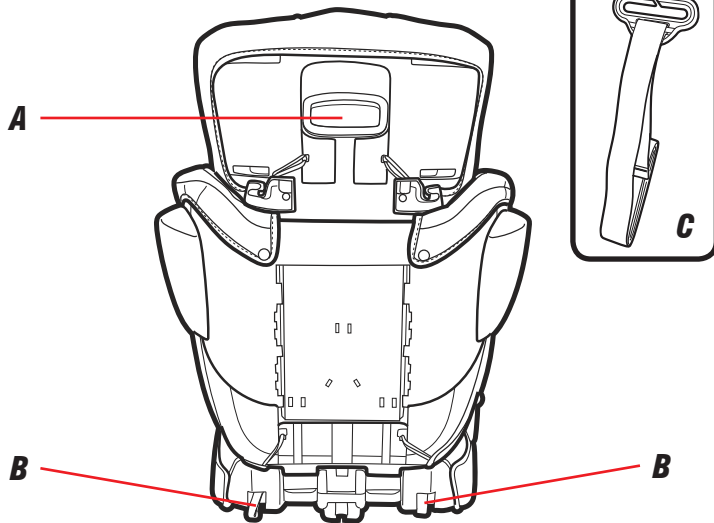

- A Head Support Adjustment Lever***
- B Lower Anchor Hooks***
- C Belt Positioning Clip (Inset)***

## 3-A Booster Use

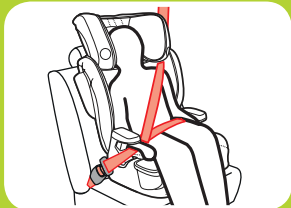

**Vehicle Lap/Shoulder Seat Belt**



**Vehicle Seat Lap/Shoulder Belt**

**Booster Use With Back:**  
**30-100 lb (14-45 kg) 38-57 in.**  
**(96-145 cm) at least 4 years old**

**Booster Use Without Back: 40-110 lb (18.1-50 kg) 43-57 in. (110.1-145 cm) at least 4 years old**

- Place car seat forward-facing in the vehicle back seat.
- Make sure vehicle seat's lap belt is adjusted snugly and lays low on the child's hip and is routed in front of the armrest in the booster's belt path.
- Vehicle belts **MUST** lie flat against child and **MUST NOT** be twisted.
- Vehicle seat's shoulder belt is adjusted snugly and should lie between child's neck and edge of shoulder.

- **Never** use a vehicle lap-only belt across front of child.
- **DO NOT** position vehicle shoulder belt under the child's arm or back.
- **DO NOT** allow child to slouch or slide down in the booster seat.
- **DO NOT** position vehicle belt over top of armrests.
- Vehicle's seat headrest **SHOULD NOT** create a gap between vehicle seat and booster seat.
- The front of booster seat **MUST NOT** hang over front of vehicle seat.
- If child will not keep vehicle belt properly positioned, **DO NOT** use this booster seat. Use a different car seat.



***Never Use a Vehicle Lap-Only Belt Across Front of Child***

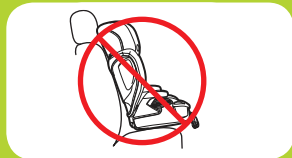
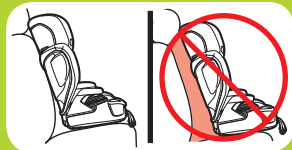

**3 Booster**



## 3 Booster

### 3-B Install Booster

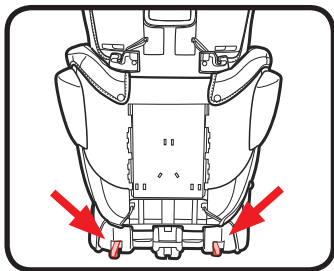

Graco allows the securing of the car seat with the lower anchor system in the booster mode. The child still **MUST BE SECURED** with the vehicle lap/shoulder seat belt. The lower anchors can be used in the booster mode regardless of the weight of the child up to 110 lb (50 kg).

Verify the following before using the lower anchors in the booster mode:

- The lower anchor attachment **DOES NOT** interfere with any vehicle seat belts or buckles.

If the lower anchor attachment interferes with the vehicle seat belts or if the chosen seating position does not have lower anchor bars, you **MUST** store the lower anchor straps. Always secure car seat with the lower anchors or a vehicle seat belt, even when unoccupied. In a crash, an unsecured car seat can injure passengers.



## 1. Place Car Seat Forward-Facing in Back Seat of the Vehicle

Place forward-facing in vehicle seat. The bottom of the seat should sit as flat as possible on the vehicle seat.



  
3 Booster

**Skip to Step 5 if Not Using the Lower Anchors**

## 2. Extend the Lower Anchor Straps.

For easier installation, extend the lower anchor straps to their maximum length by pressing the red button on the front of the base and pulling out on the straps.

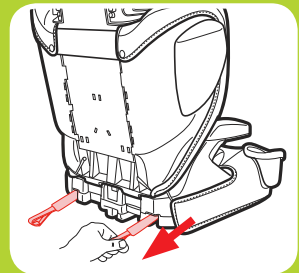
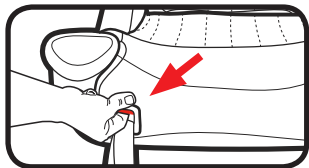



## 3 Booster

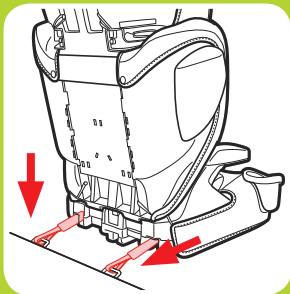

### **3. Attach Lower Anchor Connectors to Vehicle's Lower Anchor Bars.**

Lower Anchor straps should not be twisted.

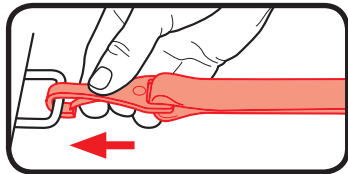

### **4. Tighten the Lower Anchor Straps**

Remove all the slack from the lower anchor straps by pushing on the booster and pulling straps on front of the booster.

**5. Thread the Vehicle Seat Shoulder Belt Through  
Seat Belt Guide on the Headrest**

See section 4-A to secure your child.

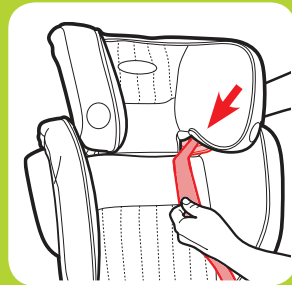

**3 Booster**



## 3-C Install Backless Booster

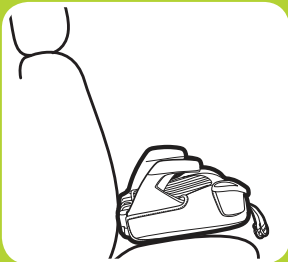
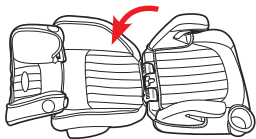

### 1. Remove the Back Support

Recline seat back then remove from base.

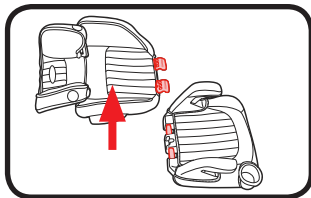

### 2. Place the Booster Seat Forward-Facing in the Back Seat of Vehicle

Place forward-facing on a vehicle seat that has a lap/shoulder seat belt. The base should sit as flat as possible on the vehicle seat.

**See section 4 to secure your child.**

## 2. **Extend the Lower Anchor Straps.**

For easier installation, extend the lower anchor straps to their maximum length by pressing the red button on the front of the base and pulling out on the straps.

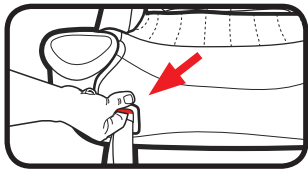

## 3. **Attach Lower Anchor Connectors to Vehicle's Lower Anchor Bars.**

Lower Anchor straps should not be twisted.

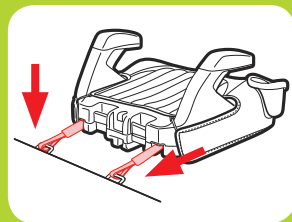
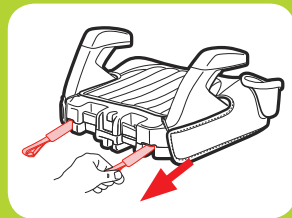
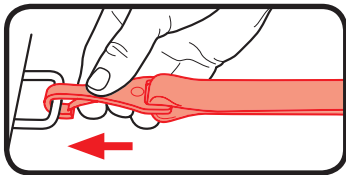

  
3 Booster



### 3 Booster

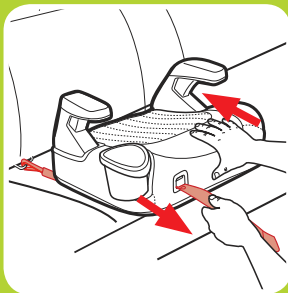

#### **4. Tighten the Lower Anchor Straps**

Remove all the slack from the lower anchor straps by pushing on the booster and pulling straps on front of the booster.

## 4-A Securing Child Backed Booster

### **! WARNING!**

**Use only the vehicle lap and shoulder belt system when restraining the child in the booster seat.**

#### **1. Place Child In Seat**

Have your child sit in the booster seat, with his/her back flat against the back of the booster seat.

#### **2. Thread Vehicle's Shoulder Belt Into Seat Belt Guide in the Headrest**

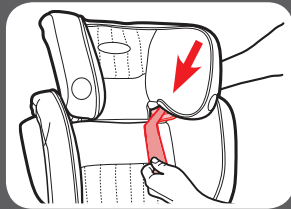

4 Securing  
Child

4 Securing  
Child

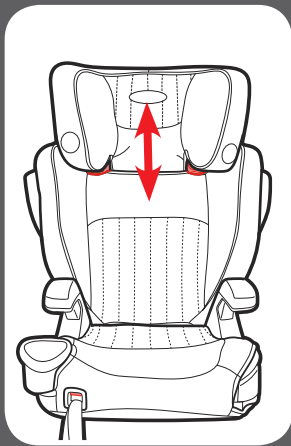

*Forward-Facing*

**3. To Raise or Lower Headrest Support**

Lift adjustment lever and lift or lower headrest for the proper harness height.

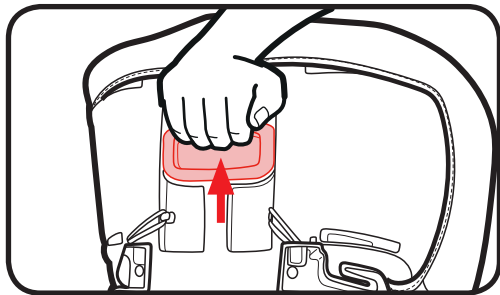



#### 4. **Buckle the Vehicle Lap/Shoulder Seat Belt**

Be sure the lap portion of the vehicle seat belt goes in front of both armrests and the shoulder belt goes under the armrest on the buckle side.

Be sure the lap portion of the vehicle seat belt lies low across your child's hips.

Be sure the shoulder belt lies across your child's shoulders, between the neck and edge of shoulder by raising or lowering the head support. The belt guides should be even with or just above the shoulders.

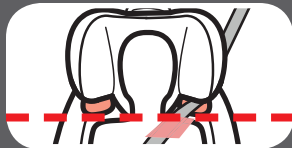
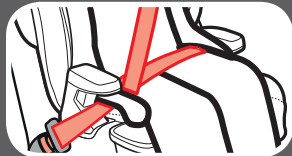
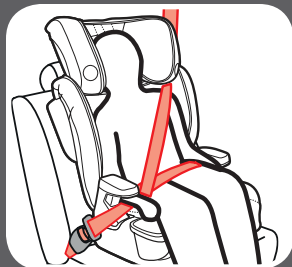



***Is Everything Correct?***



***Never Use Lap Belt Only***

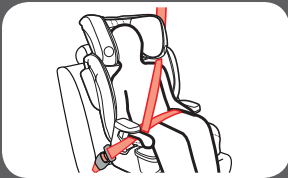

***Lap Belt in Front of Armrest and Lies Low Across Hips and Thighs***

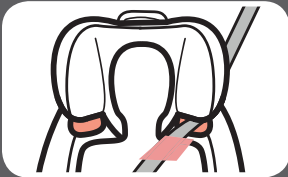

***Shoulder Belt Lies On the Shoulder, Between the Neck and Edge of Shoulders***

## 4-B Securing Child Backless Booster

### **! WARNING!**

**Use only the vehicle lap and shoulder belt system when restraining the child in the booster seat.**

#### **1. Place Child In Seat**

Have your child sit in the booster seat, with his/her back flat against the back of the vehicle seat.

#### **2. Ears Must Be Below the Top of the Vehicle Seat Back or Headrest.**

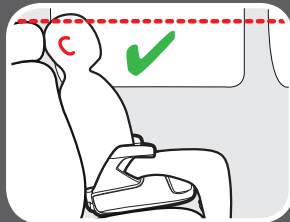

4 Securing  
Child



4 Securing  
Child

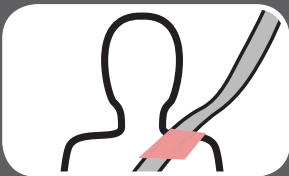
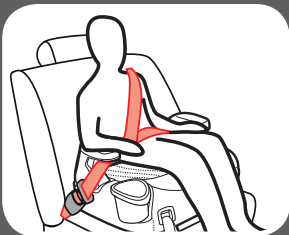

### **3. Buckle the Vehicle Lap/Shoulder Seat Belt**

Be sure the lap portion of the vehicle seat belt goes in front of both armrests and the shoulder belt goes under the armrest on the buckle side.

Be sure the lap portion of the vehicle seat belt lies low across your child's hips.

Be sure the shoulder belt lies across your child's shoulders, between the neck and edge of shoulder.

**You may need to use the belt positioning clip to help get a good fit. See “Using Belt Positioning Clip”**

***Is Everything Correct?***

***Never Use Lap Belt Only***

***Lap Belt in Front of Armrest and Lies Low Across Hips and Thighs***

***Shoulder Belt Lies On the Shoulder, Between the Neck and Edge of Shoulders***

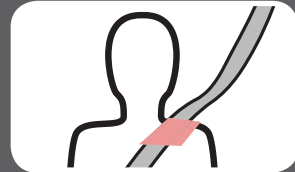
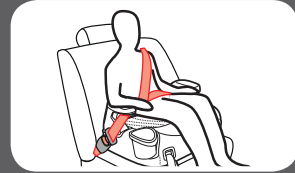

**4 Securing  
Child**



## Using Belt Positioning Clip

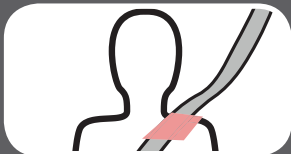

### 1. Make Sure Vehicle's Seat Shoulder Belt Lays in the Red Zone As Shown

If the vehicle's seat shoulder belt lays outside this zone, you **MUST** use the belt positioning clip.

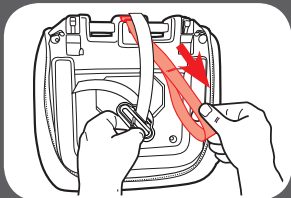

### 2. Attach Belt Positioning Clip

The shoulder belt positioning clip **MUST** be attached to the slot on the bottom of the base. Insert the loop end of strap through the slot on bottom of seat exactly where shown.



### 3. Push Clip and Strap Through Loop

Pass the clip and the strap through the loop end as shown and pull strap up.

#### **4. Free End of Strap Should Face Front of Seat**

#### **5. Place Child in Seat, Buckle Child In Seat and Attach Belt Positioning Clip**

With child's back flat against the back of the vehicle seat, buckle child in. Then slide the clip onto the vehicle's seat shoulder belt as shown.

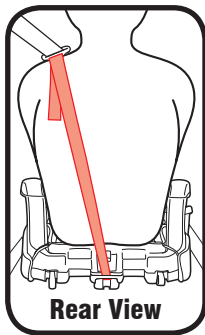

39

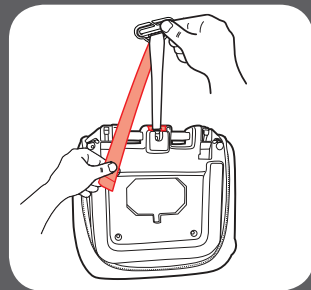

4 Securing  
Child



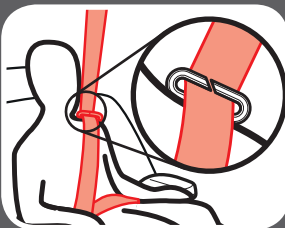
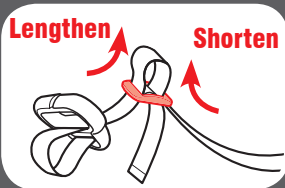

## 6. Adjust the *Belt Positioning Clip* to Fit Your Child

Lengthen or shorten the belt length as shown.

Clip should fit right at the top of shoulder as shown.

Be sure the lap portion of the vehicle seat belt lies low across your child's hips.



## 5 Accessories *(on select models)*

### ***Cup Holder***

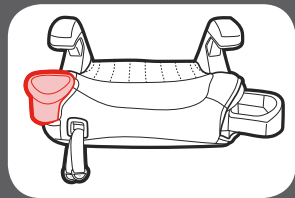

### ***Storage Compartment***

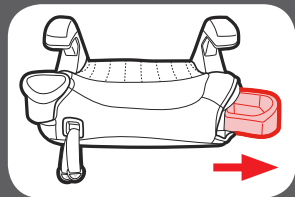



## 6-A How to Remove Lower Anchor Connectors

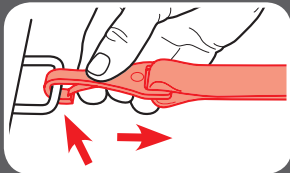
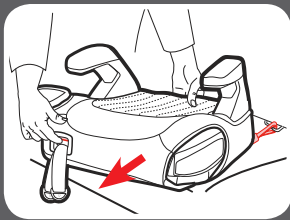

### ***Lower Anchor Connector***

Push release button up on front of booster and pull slightly away from seat.

Press in on the hook's spring. Push hook in, lift hook up, twist and pull out away from anchor point.

## 6-B Choosing Vehicle Seat Location

*Review your vehicle's owner manual for Seating Locations*

***The best seating location for this car seat is one that:***

- Is recommended by your vehicle owner's manual, and
- Results in a secure installation of this car seat

In the event there is no available back seat and / or you have no other option, the National Highway Traffic Safety Administration (NHTSA) recommends that you take the following steps:

- Ensure the child is properly restrained according to their age and size
- Move the seat as far back as possible
- Make sure the child is not leaning out of position, such as leaning forward into the deployment path of the air bag
- Set the air bag ON-OFF switch, if available, to the OFF position





## 6-C Unsafe Vehicle Seat Location

Never install this car seat in any of the following vehicle seating locations:



rear-facing or side-facing  
vehicle seats



booster mode with vehicle  
lap belt only seat belt



## 6-D Vehicle Seat Belts

*Review your vehicle's owner manual for vehicle seat belt use*

### *Vehicle Seat Belt Terms*

#### **Retractor**

A device that winds up the unused vehicle seat belt. It is often hidden inside the panels on the walls of the vehicle or in the vehicle seatback.

#### **Latch Plate**

The male end of the seat belt with the silver tongue.

#### **Seat Bight**

The crease where the vehicle seat back and seat bottom meet.

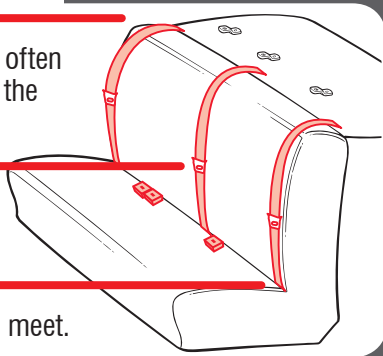



## Identify Your Seat Belt Type

There is one type of vehicle seat belt that can be used with this car seat:

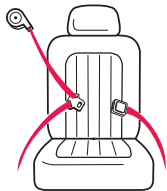

**Lap/Shoulder Belt 3**  
connections points. Can be  
used in all car seats modes  
of use.

The following types of vehicle seat belts **CANNOT** be used safely with this car seat:



Lap Belt Only 2  
connection points.



Lap Belt with Motorized  
Shoulder Belt



Lap Belt or Shoulder  
Belt Mounted on Door



Belts Forward of  
the Seat Bight

## 7-A Cleaning Seat Pad

Refer to seat pad care tag for washing instructions.

### ***Head Support Cover***

Clean with a damp sponge using mild soap and cool water. If needed, head support cover may be removed for cleaning.

To remove, raise the head support and undo the 2 elastic loops.

Pull off head support cover as shown

Machine wash cover in cold water on delicate cycle and drip-dry. **DO NOT USE BLEACH.**

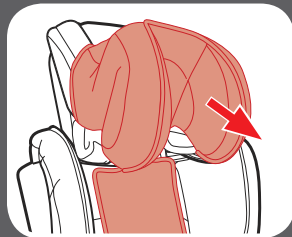
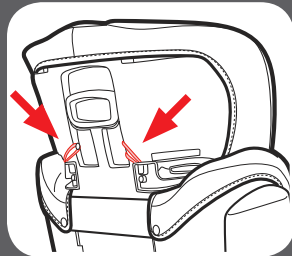

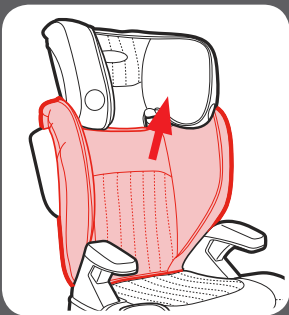
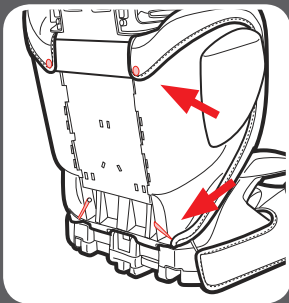

## **Seat Cover**

Clean with a damp sponge using mild soap and cool water. If needed, seat cover may be removed for cleaning.

Machine wash cover in cold water on delicate cycle and drip-dry. **DO NOT USE BLEACH.**

To remove, undo the 2 snaps and 2 elastic loops on the seat back.

Pull up on seat back cover as shown.



Undo the 2 elastic loops on each side on the back of the seat.

Remove seat cover bottom as shown.

Reverse the steps to reattach the seat cover.

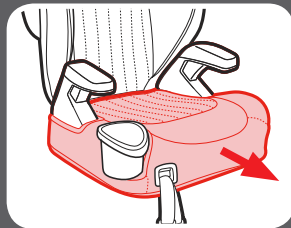
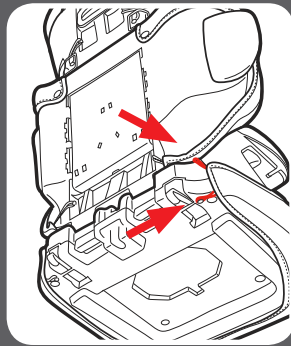

## 7-B Cleaning Lower Anchor Straps

Surface wash only with mild soap and damp cloth. **DO NOT IMMERSE THE LOWER ANCHOR STRAPS IN WATER** Doing so may weaken the straps.

If lower anchor straps are frayed or heavily soiled, contact Customer Service at [www.gracobaby.com](http://www.gracobaby.com) or 1-800-345-4109.

# Notes

## Replacement Parts

To purchase parts or accessories in the United States,  
please contact us at the following:

**[www.gracobaby.com](http://www.gracobaby.com)**

or

**1-800-345-4109**



Store instruction manual in  
the slot with the instruction  
book icon as shown.

